

Fitting  
Instructions  
included



**Freeflow**<sup>®</sup>  
RAINWATER SYSTEMS

**Freefoam**  
Building Products



## Freeflow®

Freeflow is a range of innovative, high quality PVC-U rainwater systems that are the result of Freefoam's culture of continuous innovation and investment in research and development. The Freeflow range has been designed to ensure both reliable, leak-free performance and quick installation. In addition, it is

compatible with other rainwater systems with a range of adaptors. Freeflow products come in a range of standard colours including White, Black, Leather Brown, Caramel and Anthracite Grey.

## Colours

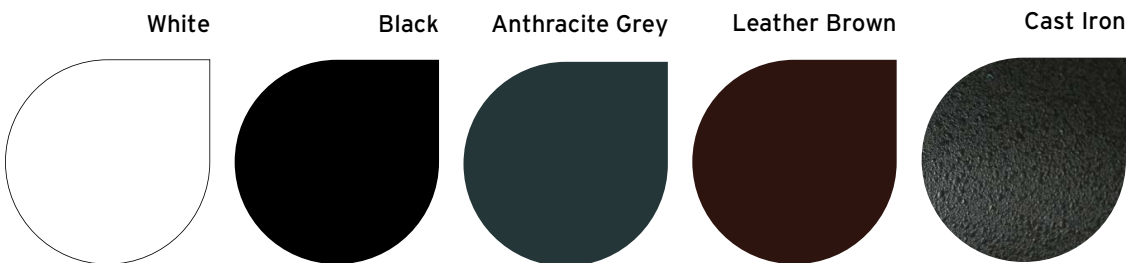

Find out more online at  
[www.freefoam.com](http://www.freefoam.com)

# Contents

<b>Introduction</b>	<b>4-5</b>
<b>Freeflow Rainwater Systems</b>	<b>6-20</b>
Square Line Rainwater System	<b>6-8</b>
Half-Round Rainwater System	<b>9-11</b>
Ogee Rainwater System	<b>12-14</b>
Deep Rainwater System	<b>14-15</b>
Cast Iron Style Rainwater System	<b>16-19</b>
<b>Steel Gutter Brackets</b>	<b>20</b>
<b>Rainwater Compatability Table</b>	<b>20</b>
<b>Rainwater Run off &amp; Gutter Capacity</b>	<b>21</b>
<b>Installation Guide</b>	<b>22-23</b>



## Major Benefits

- **Coextruded to Reduce Main Cause of Leaks**

Each rainwater system is co-extruded with a white interior and a range of exterior colours - Freefoam's new innovative solution to the problems associated with rapid heat absorption and expansion of gutters. Widely published test results show that while a white surface exposed to sunshine can absorb heat and attain a surface temperature 10°C or more over the air temperature, dark surfaces can rise a further 30-40°C and exceed the softening point of the PVC. On large capacity gutters with a large surface area facing the sun, this can be a particular problem. While the interior will be exposed to sunlight as normal, its absorption of heat from the sun and subsequent expansion along its width and length will be significantly reduced, thus dramatically decreasing the probability of any associated problems.

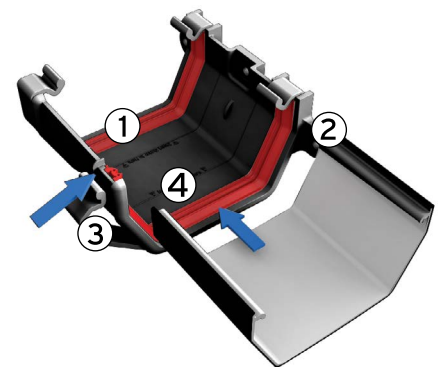

- 1 Long-life-advanced compressible seals
- 2 Co-extruded coloured gutter
- 3 Clip System
- 4 Fix-line for easy accurate installation



- **Long-life Advanced Compressible Seals for Water-tight Joints**  
All Freeflow® gutter accessories are manufactured with our advanced long-life compressible seals which results in flexible water-tight joints when lengths of guttering are connected together. The seals also allow the gutters to move without making a noise and without creating the gaps which cause leaks.

- **Long Lifetime Guarantee**  
A 50 Year Lifetime Guarantee is available on all registered white Freeflow installations, while a 10 year guarantee is available on most other colours. Customers not availing of the online registration system to obtain a certificate will qualify for the standard 20 year guarantee on all white products. All guarantees are subject to terms and conditions (see [www.myfreefoam.com](http://www.myfreefoam.com) for details).



- **Protective Film on All Gutters and Downpipes to Avoid Scratches**

All Freeflow gutters and downpipes come covered with protective film so they can survive knocks in transit and can be installed without scratches.



- **Environmentally Sustainable System**

Freeflow® rainwater systems are manufactured using a combination of recycled and virgin materials to minimise environmental impact and optimise product performance. Recycled content varies, however it is typically up to 85%. All recycled material used is 100% lead free Freefoam material.



- **Complete Range of Roofline Products**

Freefoam offers a fully integrated suite of products. In addition to the Freeflow rainwater range, Freefoam also produces a comprehensive range of roofline products providing a complete solution based around products that are designed to work together.



Find out more online at  
[www.freefoam.com](http://www.freefoam.com)

## Square Line Rainwater System

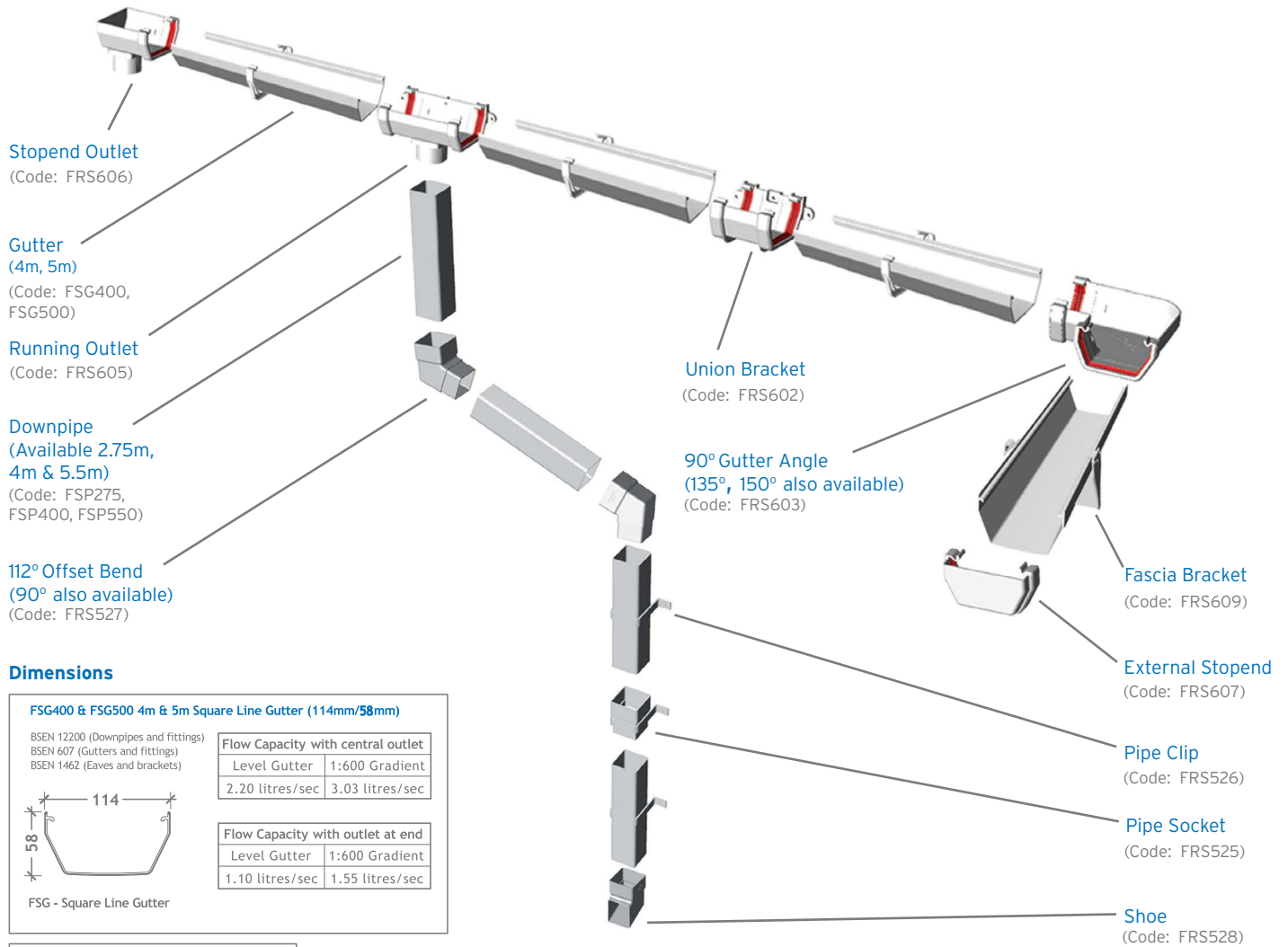

### Dimensions

#### FSG400 & FSG500 4m & 5m Square Line Gutter (114mm/58mm)

BSEN 12200 (Downpipes and fittings)  
BSEN 607 (Gutters and fittings)  
BSEN 1462 (Eaves and brackets)

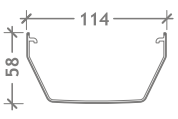

FSG - Square Line Gutter

Flow Capacity with central outlet	
Level Gutter	1:600 Gradient
2.20 litres/sec	3.03 litres/sec

Flow Capacity with outlet at end	
Level Gutter	1:600 Gradient
1.10 litres/sec	1.55 litres/sec

#### FSP Square Pipe System (65mm / 65mm)

BSEN 12200 (Downpipes and fittings)  
BSEN 607 (Gutters and fittings)  
BSEN 1462 (Eaves and brackets)

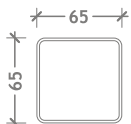

FSP - Square Pipe

### Colours



White



Black



Leather Brown

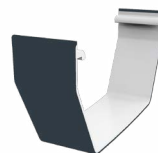

Anthracite Grey

	DESCRIPTION	CODE	COLOURS	<sup>1</sup> BOX / PACK QUANTITIES
	Gutter <sup>2</sup> (4m, 5m)	FSG400 FSG500	White Black Leather Brown Anthracite Grey	6
	150° Gutter Angle	FRS601	White Black Leather Brown	24/1
	Union Bracket	FRS602	White Black Leather Brown Anthracite Grey	24/6
	90° Gutter Angle	FRS603	White Black Leather Brown Anthracite Grey	20/1
	135° Gutter Angle	FRS604	White Black Leather Brown Anthracite Grey	26/1
	Running Outlet	FRS605	White Black Leather Brown Anthracite Grey	16/1
	Stopend Outlet	FRS606	White Black Leather Brown Anthracite Grey	30/1
	External Stopend	FRS607	White Black Leather Brown Anthracite Grey	135/15
	Internal Stopend	FRS608	White Black Leather Brown Anthracite Grey	200/10
	Square Fascia Bracket	FRS609	White Black Leather Brown	150/25
	Square to Round Gutter Adaptor	FRS611	White Black Leather Brown	55/11
	Ogee to Square Gutter Adaptor	FRO611	White Black Leather Brown	40/10

<sup>1</sup> All items must be ordered in pack quantities.

<sup>2</sup> Square or round pipe systems may be fitted to the square line gutter system.

	DESCRIPTION	CODE	COLOURS	<sup>1</sup> BOX / PACK QUANTITIES
	Pipe (2.75m;4m;5.5m)	FSP275 FSP400 FSP550	White Black Leather Brown Anthracite Grey	6 6 6
	90° Offset Bend	FRS524	White Black Leather Brown Anthracite Grey	40/10
	Pipe Socket	FRS525	White Black Leather Brown Anthracite Grey	100/10
	Square Pipe Clip (Stand-off)	FRS526	White Black Leather Brown Anthracite Grey	200/10
	Square Pipe Clip (Flush)	FRS536	White Black Leather Brown Anthracite Grey	240/30
	112° Offset Bend	FRS527	White Black Leather Brown Anthracite Grey	30/5
	Square Shoe	FRS528	White Black Leather Brown Anthracite Grey	56/14
	112° Branch	FRS529	White Black Leather Brown Anthracite Grey	20/10
	Square to Round Downpipe Adaptor	FRS531	White Black Leather Brown Anthracite Grey	100/10
	Mini Offset	FRS532	White Black Leather Brown	20/1
	Access Pipe	FRS533	White Black Leather Brown	20/4

<sup>1</sup> All items must be ordered in pack quantities.

## Half Round Rainwater System

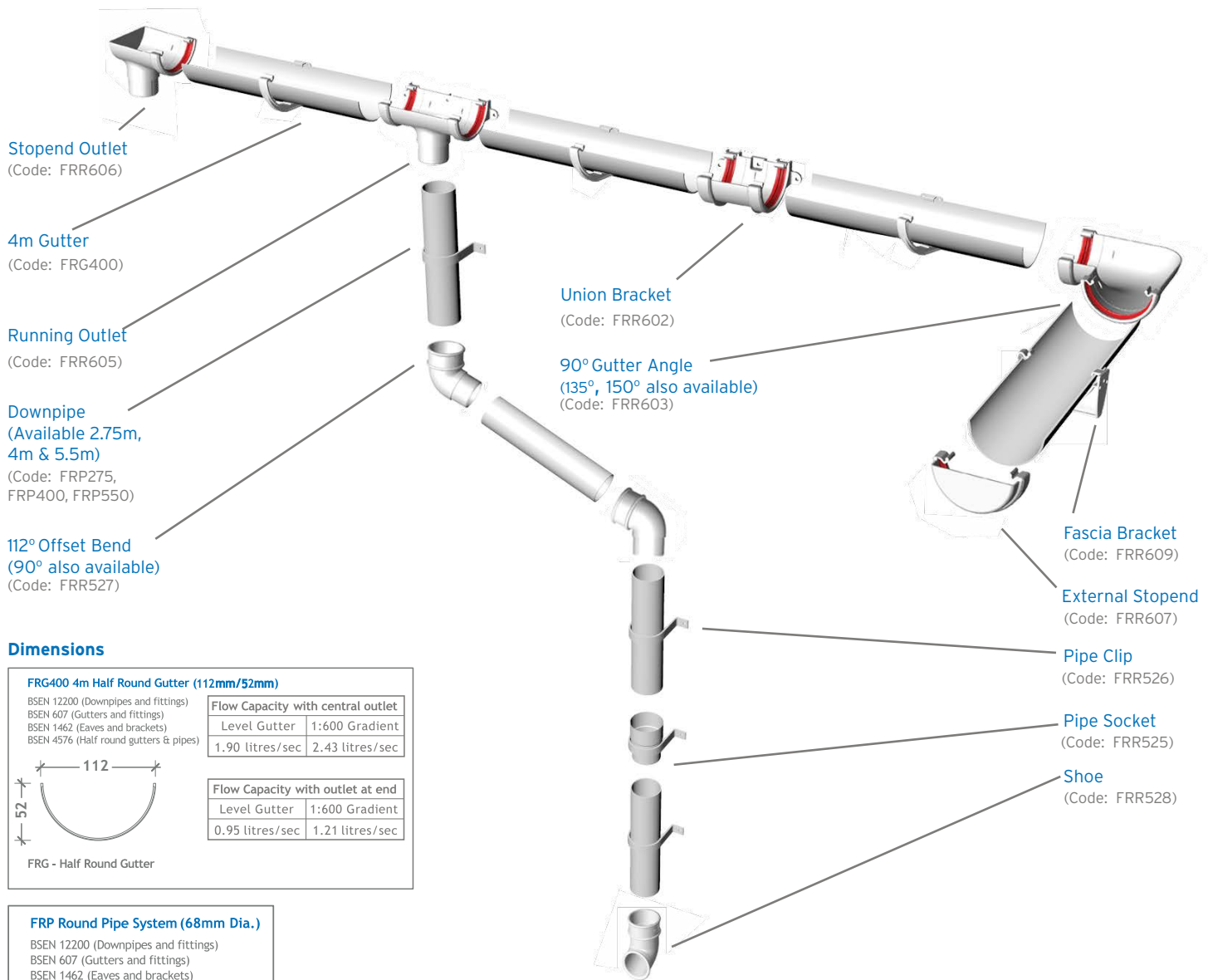

### Dimensions

**FRG400 4m Half Round Gutter (112mm/52mm)**

BSEN 12200 (Downpipes and fittings)  
BSEN 607 (Gutters and fittings)  
BSEN 1462 (Eaves and brackets)  
BSEN 4576 (Half round gutters & pipes)

Flow Capacity with central outlet	
Level Gutter	1:600 Gradient
1.90 litres/sec	2.43 litres/sec

Flow Capacity with outlet at end	
Level Gutter	1:600 Gradient
0.95 litres/sec	1.21 litres/sec

FRG - Half Round Gutter

**FRP Round Pipe System (68mm Dia.)**

BSEN 12200 (Downpipes and fittings)  
BSEN 607 (Gutters and fittings)  
BSEN 1462 (Eaves and brackets)

FRP - Round Pipe





### Colours



	DESCRIPTION	CODE	COLOURS	<sup>1</sup> BOX / PACK QUANTITIES
	4m & 5m Gutter <sup>2</sup>	FRG400 FRG500	White Black Leather Brown Anthracite Grey (FRG400 only)	6 6
	150° Gutter Angle	FRR601	White Black Leather Brown	28/1
	Union Bracket	FRR602	White Black Leather Brown Anthracite Grey	30/6
	90° Gutter Angle	FRR603	White Black Leather Brown Anthracite Grey	22/1
	135° Gutter Angle	FRR604	White Black Leather Brown Anthracite Grey	30/1
	Running Outlet	FRR605	White Black Leather Brown Anthracite Grey	18/1
	Stopend Outlet	FRR606	White Black Leather Brown Anthracite Grey	30/1
	External Stopend	FRR607	White Black Leather Brown Anthracite Grey	120/15
	Internal Stopend	FRR608	White Black Leather Brown Anthracite Grey	270/30
	Half Round Fascia Bracket	FRR609	White Black Leather Brown Anthracite Grey	180/30
	Square to Round Gutter Adaptor	FRS611	White Black Leather Brown	55/11
	Ogee to Round Gutter Adaptor	FRR611	White Black Leather Brown	40/10

<sup>1</sup> All items must be ordered in pack quantities.

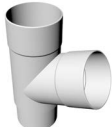
<sup>2</sup> Square or round pipe systems may be fitted to the half round gutter system.

	DESCRIPTION	CODE	COLOURS	<sup>1</sup> BOX / PACK QUANTITIES
	Pipe (2.75m; 5.5m)	FRP275 FRP550	White Black Leather Brown Anthracite Grey	6 6
	Pipe (4m)	FRP400	White Black Leather Brown Anthracite Grey	6 6 6 6
	90° Offset Bend	FRR524	White Black Leather Brown Anthracite Grey	40/10
	Pipe Socket	FRR525	White Black Leather Brown Anthracite Grey	100/10
	Round Pipe Clip (Stand-Off)	FRR526	White Black Leather Brown Anthracite Grey	180/30
	Round Pipe Clip (Flush)	FRR536	White Black Leather Brown	100/10
	112° Offset Bend	FRR527	White Black Leather Brown Anthracite Grey	48/12
	Shoe	FRR528	White Black Leather Brown Anthracite Grey	40/10
	112° Branch	FRR529	White Black Leather Brown Anthracite Grey	20/10
	Hopper (Fits Square, Round & Ogee)	FRR530	White Black Leather Brown Anthracite Grey	10/1
	Mini Offset	FRR532	White Black Leather Brown	20/1
	Access Pipe	FRR533	White Black Leather Brown	20/4

## Ogee Rainwater System

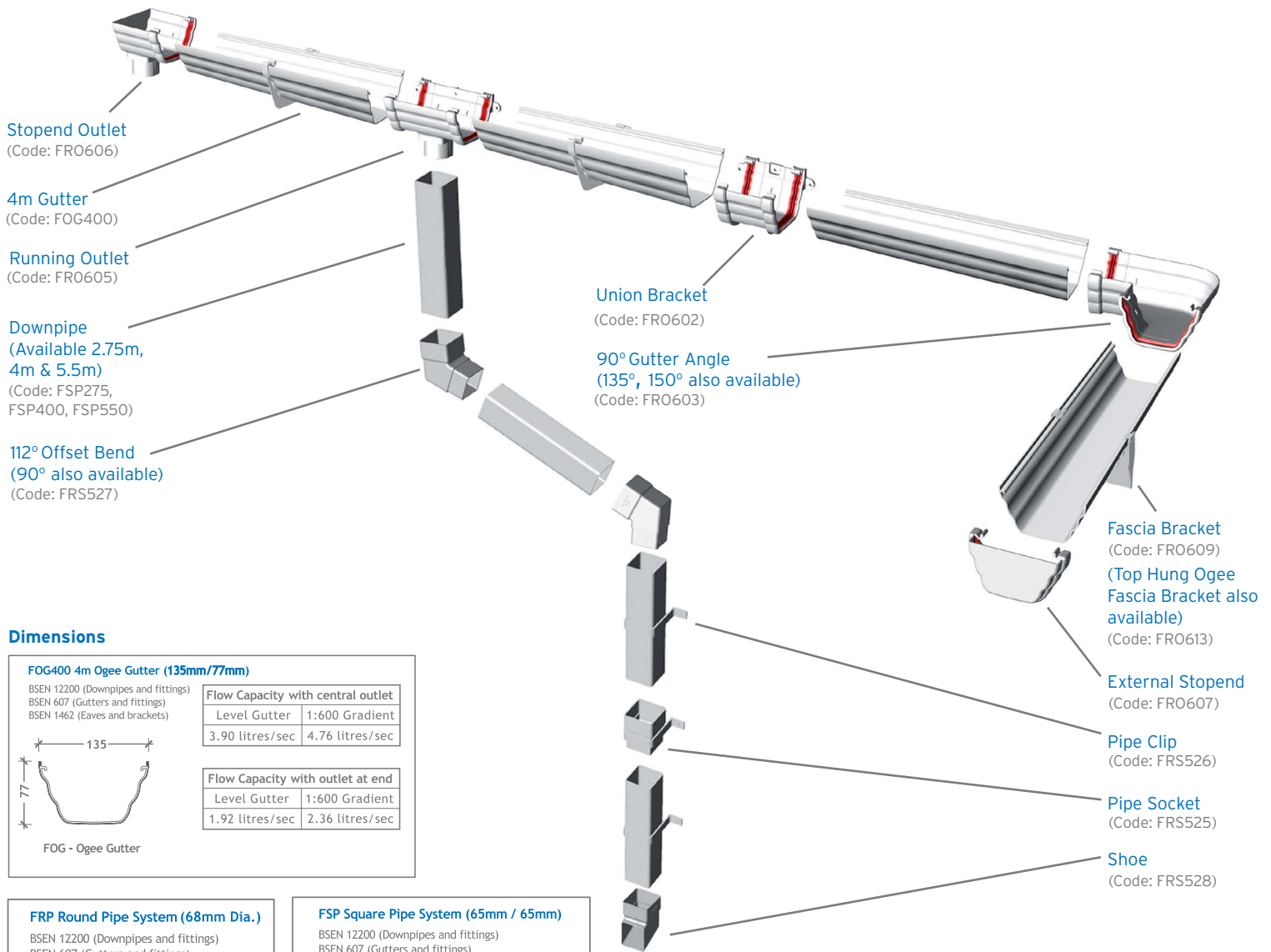

### Dimensions

**FOG400 4m Ogee Gutter (135mm/77mm)**  
 BSEN 12200 (Downpipes and fittings)  
 BSEN 607 (Gutters and fittings)  
 BSEN 1462 (Eaves and brackets)

Flow Capacity with central outlet	
Level Gutter	1:600 Gradient
3.90 litres/sec	4.76 litres/sec

Flow Capacity with outlet at end	
Level Gutter	1:600 Gradient
1.92 litres/sec	2.36 litres/sec

FOG - Ogee Gutter

**FRP Round Pipe System (68mm Dia.)**  
 BSEN 12200 (Downpipes and fittings)  
 BSEN 607 (Gutters and fittings)  
 BSEN 1462 (Eaves and brackets)

FRP - Round Pipe

**FSP Square Pipe System (65mm / 65mm)**  
 BSEN 12200 (Downpipes and fittings)  
 BSEN 607 (Gutters and fittings)  
 BSEN 1462 (Eaves and brackets)

FSP - Square Pipe

### Colours



White

Black



Brown

Anthracite Grey

	DESCRIPTION	CODE	COLOURS	<sup>1</sup> BOX / PACK QUANTITIES
	Gutter (4m) <sup>2</sup>	FOG400	White Black Leather Brown Anthracite Grey	4
	150° Gutter Angle	FRO601	White Black Leather Brown	10/1
	Union Bracket	FRO602	White Black Leather Brown Anthracite Grey	22/1
	90° Gutter Angle	FRO603	White Black Leather Brown Anthracite Grey	10/1
	135° Gutter Angle	FRO604	White Black Leather Brown Anthracite Grey	12/1
	Running Outlet	FRO605	White Black Leather Brown Anthracite Grey	12/1
	Stopend Outlet	FRO606	White Black Leather Brown Anthracite Grey	24/1
	External Stopend	FRO607	White Black Leather Brown Anthracite Grey	80/10
	Internal Stopend	FRO608	White Black Leather Brown Anthracite Grey	100/10
	Ogee Fascia Bracket	FRO609	White Black Leather Brown Anthracite Grey	100/20

<sup>1</sup> All items must be ordered in pack quantities.

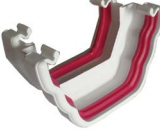
<sup>2</sup> Square or round pipe systems may be fitted to the ogee gutter system.

	DESCRIPTION	CODE	COLOURS	1 BOX / PACK QUANTITIES
	Ogee to Square Gutter Adaptor	FRO611	White Black Brown	40/10
	Ogee to Round Gutter Adaptor	FRR611	White Black Brown	40/10
	Top Hung Ogee Fascia Bracket	FRO613	White Black Brown	150/25

## Deep Rainwater System

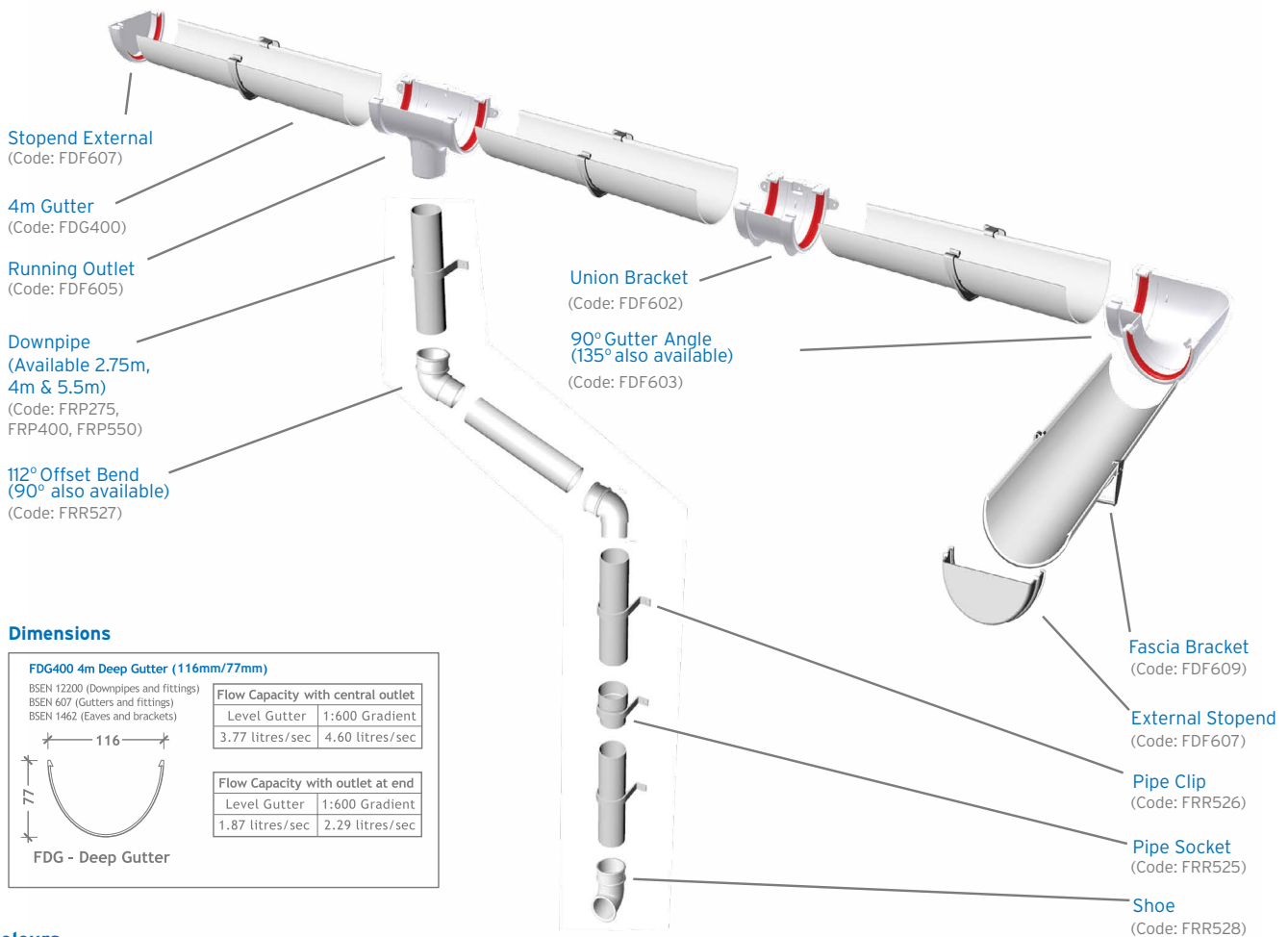

### Dimensions

FDG400 4m Deep Gutter (116mm/77mm)							
BSEN 12200 (Downpipes and fittings)	<table border="1"> <thead> <tr> <th colspan="2">Flow Capacity with central outlet</th> </tr> <tr> <th>Level Gutter</th> <th>1:600 Gradient</th> </tr> </thead> <tbody> <tr> <td>3.77 litres/sec</td> <td>4.60 litres/sec</td> </tr> </tbody> </table>	Flow Capacity with central outlet		Level Gutter	1:600 Gradient	3.77 litres/sec	4.60 litres/sec
Flow Capacity with central outlet							
Level Gutter	1:600 Gradient						
3.77 litres/sec	4.60 litres/sec						
BSEN 607 (Gutters and fittings)	<table border="1"> <thead> <tr> <th colspan="2">Flow Capacity with outlet at end</th> </tr> <tr> <th>Level Gutter</th> <th>1:600 Gradient</th> </tr> </thead> <tbody> <tr> <td>1.87 litres/sec</td> <td>2.29 litres/sec</td> </tr> </tbody> </table>	Flow Capacity with outlet at end		Level Gutter	1:600 Gradient	1.87 litres/sec	2.29 litres/sec
Flow Capacity with outlet at end							
Level Gutter	1:600 Gradient						
1.87 litres/sec	2.29 litres/sec						
BSEN 1462 (Eaves and brackets)							

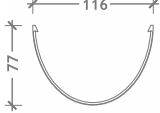

FDG - Deep Gutter

### Colours



White



Black



Brown



Anthracite  
Grey



Cast  
See pages 17-19

	DESCRIPTION	CODE	COLOURS	<sup>1</sup> BOX / PACK QUANTITIES
	Gutter (4m) <sup>2</sup>	FDG400	White Black Brown Anthracite Grey	4
	Union Bracket	FDF602	White Black Brown Anthracite Grey	26 (2x10, 1x6)
	90° Gutter Angle	FDF603	White Black Brown Anthracite Grey	15/1
	135° Gutter Angle	FDF604	White Black Brown Anthracite Grey	24/1
	Running Outlet	FDF605	White Black Brown Anthracite Grey	14/1
	External Stopend	FDF607	White Black Brown Anthracite Grey	96/12
	Internal Stopend	FDF608	White Black Leather Brown Anthracite Grey	300/30
	Fascia Bracket	FDF609	White Black Brown Anthracite Grey	150/25
	Deep to Round Adaptor	FDF611	White Black Brown Anthracite Grey	40/10





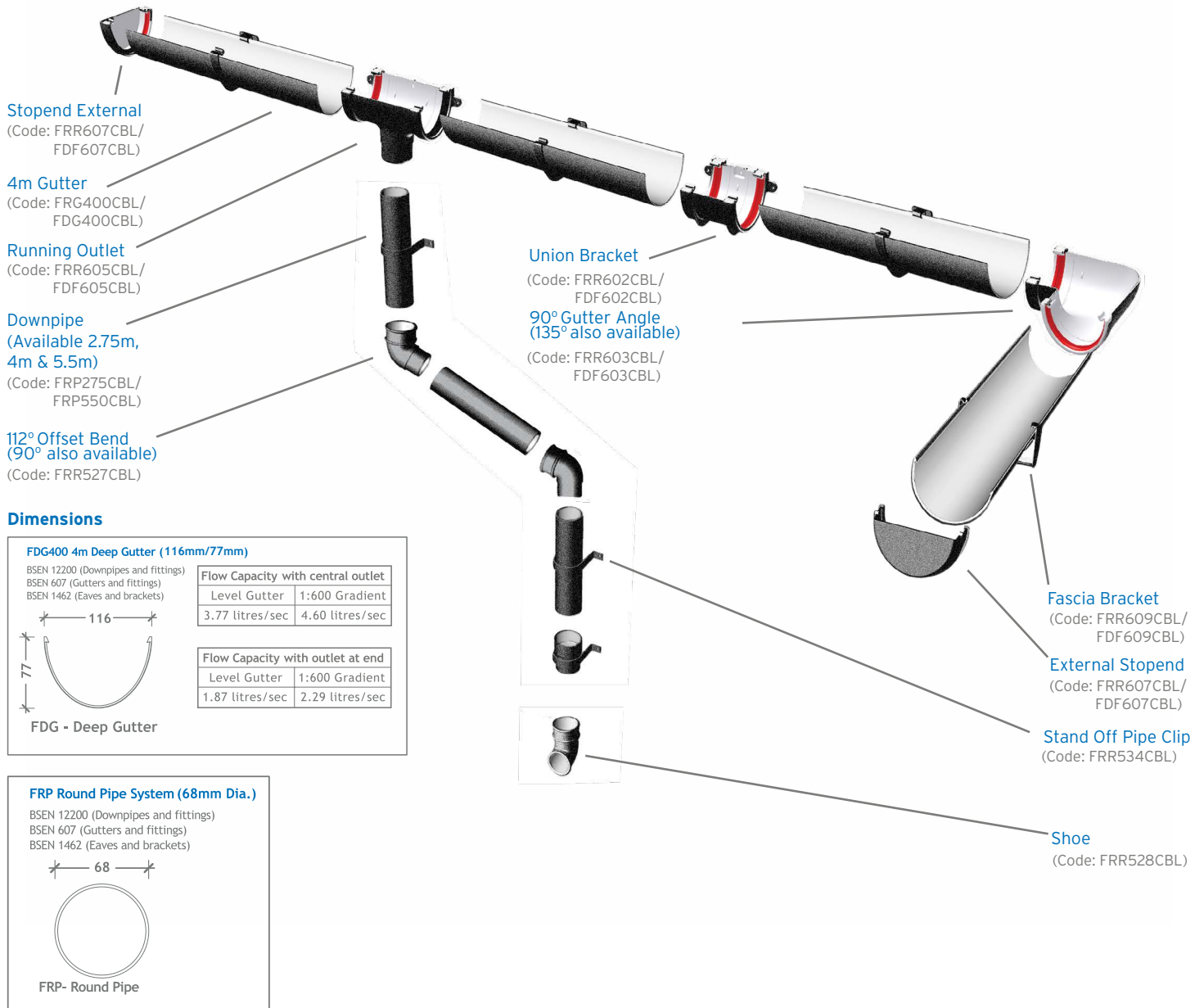

<sup>1</sup> All items must be ordered in pack quantities.

<sup>2</sup> Square or round pipe systems may be fitted to the deep gutter system.



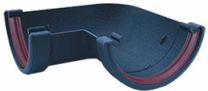



# Cast Iron Round and Deep Rainwater System

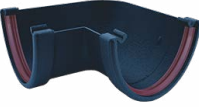

The new Freeflow® Cast Iron Style Rainwater System has been designed to provide the authentic look and feel of traditional cast iron rainwater systems with all the benefits of a modern, low-maintenance and fitter-friendly system. The system is available in half round and deep styles with a full range of related accessories to ensure a neat and professional installation.

	DESCRIPTION	CODE	COLOUR	<sup>1</sup> PACK QUANTITY
	4 metre Round Gutter	FRG400CBL	Cast Iron Black	1
	Round Union Bracket	FRR602CBL	Cast Iron Black	1
	Round 90° Gutter	FRR603CBL	Cast Iron Black	1
	Round Running Outlet	FRR605CBL	Cast Iron Black	1
	Round Stopend Outlet	FRR606CBL	Cast Iron Black	1
	Round External Stopend	FRR607CBL	Cast Iron Black	1
	Round Fascia Bracket	FRR609CBL	Cast Iron Black	1

<sup>1</sup> All items must be ordered in pack quantities.

	DESCRIPTION	CODE	COLOUR	<sup>1</sup> PACK QUANTITY
	4m Deep Gutter	FDG400CBL	Cast Iron Black	1
	Deep Union Bracket	FDF602CBL	Cast Iron Black	1
	Deep 90° Bend	FDF603CBL	Cast Iron Black	1
	Deep 135° Bend	FDF604CBL	Cast Iron Black	1
	Deep Running Outlet	FDF605CBL	Cast Iron Black	1
	Deep External Stop End	FDF607CBL	Cast Iron Black	1
	Deep Fascia Bracket	FDF609CBL	Cast Iron Black	1

<sup>1</sup> All items must be ordered in pack quantities.

	DESCRIPTION	CODE	COLOUR	<sup>1</sup> PACK QUANTITY
	Round Pipe (2.75m; 5.5m)	FRP275CBL FRP550CBL	Cast Iron Black	1 1
	90° Offset Bend	FRR524CBL	Cast Iron Black	1
	Round 112° Offset Bend	FRR527CBL	Cast Iron Black	1
	Round Shoe	FRR528CBL	Cast Iron Black	1
	Round 112° Branch	FRR529CBL	Cast Iron Black	1
	Hopper	FRR530CBL	Cast Iron Black	1
	Mini Offset	FRR532CBL	Cast Iron Black	1
	Half Round Pipe Clip - stand off	FRR534CBL	Cast Iron Black	1
	Pipe Clip Collar	FRR535CBL	Cast Iron Black	1

<sup>1</sup> All items must be ordered in pack quantities.

## Steel Gutter Brackets





A range of gutter fittings manufactured from galvanized steel offering a strong durable fixing resistant to corrosion.

**Side Rafter bracket:** Used where there no fascia board in place. Screwed to side of rafters. Ideal for maintenance and renovation work as they can be installed with the roof in place.

**Rise and Fall Gutter bracket:** The ideal way to create a gradient in the gutter run. Designed for fixing into brick-work with spike.

**Adjustable Side Rafter bracket:** For use in conjunction with standard Freeflow pvc fascia brackets to create a fall. Allows up to 65mm adjustment.

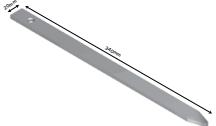
NB Standard Rafter Brackets only fit around gutter, not fittings.  
Range only suitable for Round Gutter System.

	DESCRIPTION	CODE	COLOUR	BOX QUANTITY
	Adjustable Side Rafter Bracket	FRR614	Steel	1
	Rise and Fall Bracket	FRR615	Steel	1
	Drive for Rise and Fall Bracket	FRR616	Steel	1
	Side Rafter Bracket	FRR617	Steel	1

## Rainwater Compatibility Chart

Use the table below to check compatibility of Freeflow range against other brands.

Manufacturer	112mm Half Round	Square Line
Brett Martin	✓	✓
FloPlast	✓	✓
Terrain (Polypipe)	✗	✗
Hepworth (Wavin)	✓	✓
Hunter	✓	✓
Kalsi	✓	✓
Marley (Aliaxis)	✓	✗
Marshall Tufflex (Polypipe)	✓	✗
Osma (Wavin)	✓	✗
Polypipe	✓	✓
Kayflow	✓	✓

## Calculating Rainwater Run Off (flow) of Roof

To calculate flow in litres per second for 75mm/hour rainfall intensity the formula is:

$$\text{Flow (l/s)} = \text{ERA (m}^2\text{)} \times 0.0208 \quad (\text{ERA} = \text{Effective Roof Area})$$

Where:

- H = Ridge to Eaves Height
- H/2 = Half the Ridge to Eaves Height
- W = Roof Span
- L = Length of Roof

### Example Flow Calculation

- H = 3m
- H/2 = 1.5m
- W = 3m
- L = 20m

$$\text{ERA} = (\text{H}/2) + \text{W} \times \text{L}$$

$$\text{ERA} = (1.5\text{m}) + 3\text{m} \times 20\text{m}$$

$$\text{ERA} = 4.5\text{m} \times 20\text{m}$$

$$\text{ERA} = 90\text{m}^2$$

$$\text{Flow (l/s)} = 90\text{m}^2 \times 0.0208$$

$$\text{Flow} = 1.87 \text{ l/s}$$

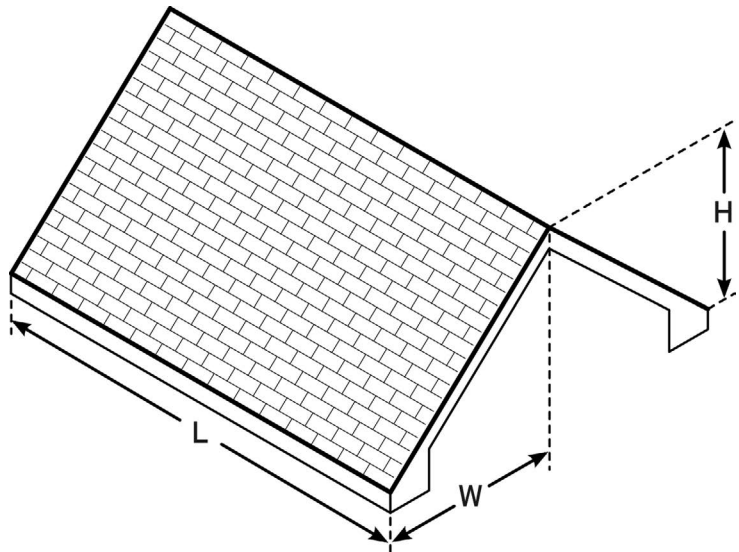

## Gutter Capacity

The gutter flow capacity of Freeflow rainwater systems is determined by the profile gutter, gutter gradient (fall) and the size and positioning of the outlets.

Best results are obtained where the outlet is at the centre of the longest run of gutter and the gutters are fitted with a 1:600 gradient.

Additionally, if a gutter angle is introduced into the rainwater gutter run the effective gutter flow capacity is reduced.

## Choosing Gutter Type and Quantity

To determine a suitable gutter profile and quantity based on calculated flow rate, refer to Table 1 and Table 2.

Table 1. Gutter flow capacity with outlet at the centre of the gutter run.

System	Gutter level	1:600 gradient
Half round	1.90 litres/sec	2.43 litres/sec
Square	2.20 litres/sec	3.03 litres/sec
Ogee	3.90 litres/sec	4.76 litres/sec
Deep	3.77 litres/sec	4.60 litres/sec

Table 2. Gutter flow capacity with outlet at the end of the gutter run.

System	Gutter level	1:600 gradient
Half round	0.95 litres/sec	1.21 litres/sec
Square	1.10 litres/sec	1.55 litres/sec
Ogee	1.92 litres/sec	2.36 litres/sec
Deep	1.87 litres/sec	2.29 litres/sec

## Installation Guide

Freeflow<sup>®</sup> rainwater systems, of square, half round, ogee or deep design, may be installed using the steps outlined below. It is important that you refer to the design guidelines outlined at the end of this installation guide prior to beginning your installation project. The design guidelines, exploded view drawings and product lists in this brochure will assist you in selecting the correct type and quantity of products required.

### Fitting Gutter

- 1 It is important to ensure gutters are fitted as high as possible to the roof edge and the roof edge should not project beyond the centre of the gutter cross section. Gutters can be fitted either level or with a slight fall. Laying the gutter with a fall will increase the flow capacity and increase the area of the roof that can be drained. Silting will also be reduced with a gutter installed with a slight fall.
- 2 Fix the gutter outlet to the fascia with 5mm (minimum) roundhead screws\* vertically above the gully from which the rainwater will be conveyed to the drainage system. Use a string-line to ensure a straight gutter, whether level or laid to a fall. Double check the desired fall is achieved, adjust as necessary. Mark out the position of every support point along this line.
- 3 Fix fascia brackets to the fascia along the line created above with 5mm (minimum) roundhead screws\* at maximum intervals of 1m. A fascia bracket should be fitted within 150mm of all stopends and angles.
- 4 The fitting of a union bracket is required at each junction of two gutter sections. Fit a stopend to complete the run. Union brackets should be fixed to the fascia with 5mm (minimum) roundhead screws\*. Unions should never be allowed to 'float' without fixing.
- 5 Starting at the gutter outlet insert the back edge of the gutter under the retaining lip of the fascia brackets. Then press down on the gutter to snap the front of the gutter in place. Fit additional gutter lengths and gutter lengths cut to size as required. When measuring gutters to be fitted, ensure that the gutter will extend to the marks on the fittings. Fittings are marked to indicate the position to which the gutter should be inserted to allow for thermal expansion.

- 6 All rainwater gutters and pipes must be squarely cut and all burrs removed. It is recommended that a fine toothed saw be used. Care must be taken when cutting gutters and pipes in cold or damp conditions.

**NOTE:** In areas subject to high winds, extra securing of brackets may be required. Any extra screws deemed advisable should only be secured through holes drilled with the necessary clearance.

### Fitting Downpipe

- 1 Fixing of the downpipe starts at the gutter outlet. An offset is generally required to join the gutter outlet or downpipe from the outlet to the downpipe on the wall. Offsets can be constructed from the range of Freeflow bends depending upon the roof overhang. All offsets should be supported directly beneath the lower offset bend by a pipe clip. Remember to allow for thermal expansion as described below.
- 2 Insert a length of square or round downpipe as preferred into the bottom of the offset bend and fix a pipe clip to the wall with 5mm (minimum) roundhead screws\*. Ensure that a gap of 10mm is left at the top of the downpipe for thermal expansion. Fix additional pipe clips as required at maximum intervals of 2m. If the downpipe is subject to impact, extra clips should be considered. Two different pipe clip fittings are available, a flush fitting and where a gap is preferable between wall and pipe, a stand off clip.
- 3 Additional lengths of downpipe may be required to reach the ground depending on the height of the building. In this case, fix a socket to the wall with a pipe clip and 5mm (minimum) roundhead screws\* at the bottom of the existing fitted downpipe and fix another length of downpipe to the wall as outlined above. Ensure that a gap of 10mm is left at the top of additional downpipes for thermal expansion.
- 4 When all downpipes have been fixed in place, connection to the drainage system can be achieved either by terminating the downpipe with a rainwater shoe for disposal either into a drain or hopper or directly into the underground drainage pipe using a rainwater pipe adaptor. The shoe or adaptor will take the rainwater from the downpipe to the drain thus reducing the possibility of surface water accumulating on the ground.

## Notes:

- 1 All screws should be non-corroding, zinc-plated, stainless steel or similar.
- 2 In areas prone to heavy snow falls, fascia brackets should be fixed at maximum intervals of 800mm
- 3 Where, due to the absence of a fascia or the design of the building, support brackets cannot be fixed, Freefoam offer a range of rafter brackets to suit each profile that is screwed to the rafter. Where a gradient is required, rise and fall brackets can be used.  
Freefoam supply a range of gutter adapters to connect to existing gutter systems. All adapters must be supported at either side of the connection. It is recommended that the joint be secured by a suitable waterproof sealant.

## Testing

When rainwater installations are complete the system should be tested for water tightness under working conditions and internal downpipes should also be tested as prescribed in the relevant Building Regulations. Guidance is also given in BS6367:1983.

## Important Note

This advice and guidance is based upon typical situations only. For assistance with specific projects, please contact Freefoam Technical Services at [info@freefoam.com](mailto:info@freefoam.com).

## British Standards

Freeflow Rainwater systems are manufactured to the following British Standards:

[BS4576](#): - Half round gutters and pipes of circular cross section manufactured in PVC-U.

[BS EN 12200](#) - Plastics rainwater systems for above ground external use manufactured in PVC-U.

[BS EN 607](#) - Eaves gutters and fittings made of PVC-U definitions, requirements and testing.

[BS EN 1462](#) - Brackets for eaves gutters - requirements and testing.

## Technical Advice and Guidance

An advisory service is available to offer technical assistance and installation details. For technical advice, email the following address: [info@freefoam.com](mailto:info@freefoam.com).

Whilst every effort is made to ensure details are accurate and up to date our continual product development and improvement programme may cause details to change.

## Maintenance

Gutters and downpipes should be cleaned out regularly, at least annually, more frequently in locations where there is wind borne debris, e.g. close to trees and sandy areas. A mild detergent solution is ideal when cleaning dirt from external surface areas.

Regularly check the security of gutters, downpipes, fittings to ensure they have not been dislodged or come loose and that the gutter extrusions have not moved beyond any thermal expansion allowance marks in the fittings.

## Design

**Rainfall Intensity:** Rainfall intensity in the UK and Ireland varies with location, however, a maximum of 75mm per hour is usually taken when calculating the discharge requirements for gutter and downpipe systems.

**Snow Loading:** BS 6367:1983 sets out the design requirements for snow loading. In areas where heavy snowfalls can be expected support brackets should be fixed at a maximum of 800mm centres.

# Freefoam Building Products

77-83 St James Mill Road,  
Northampton NN5 5JP UK  
Tel: 01604 591110 Fax: 01604 590299  
Email: ukmarketing@freefoam.com

Central Commercial Park, Centre Park Road,  
Cork T12 KC96 IRELAND  
Tel: 021 496 6311 Fax: 021 496 5273  
Email: info@freefoam.com

